

Likorall™ 200 overhead lift Instructions for Use

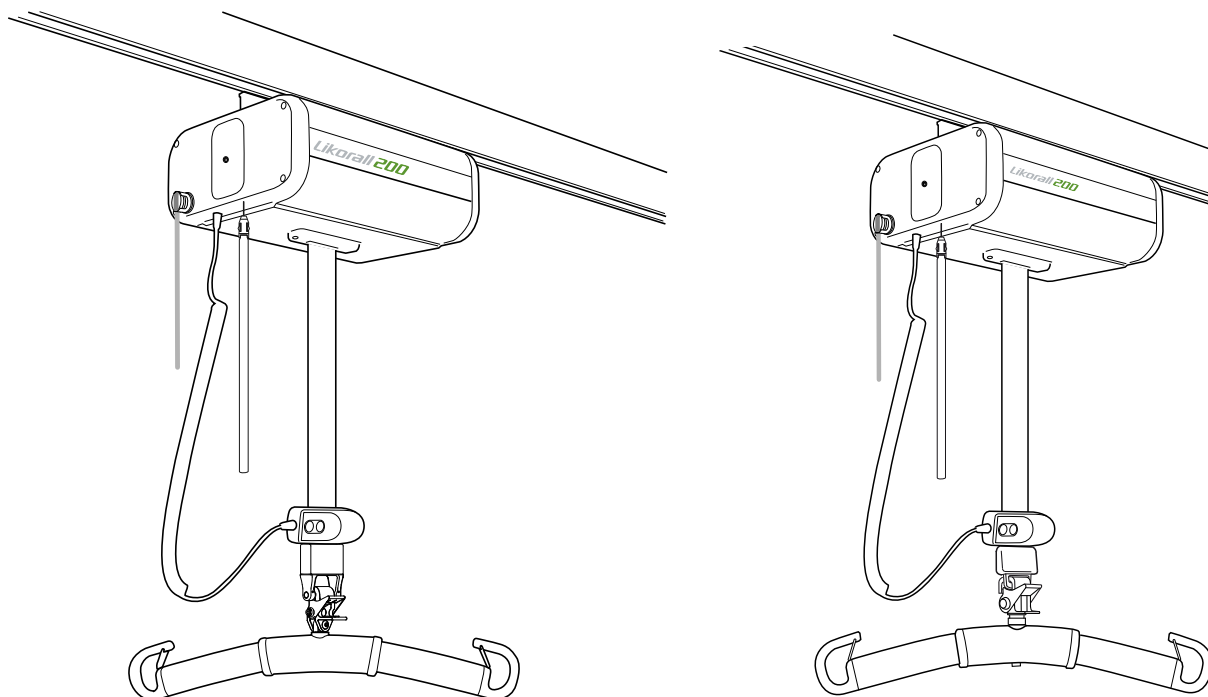

Likorall 200 overhead lift Product No. 3121001



Product Description

Likorall overhead lift is a stationary lift unit often called an “overhead lift”. Likorall overhead lift is mounted in Liko™ rail system, which is adapted to suit the room/rooms it will be operated in. The rail system can be built straight, with or without curves, as a traverse system and also as a room-to-room system. Liko™ rail system is comprised of several hundred different components, we select the specific components needed to customize each system to suit the room it will be mounted in. The rail system can either be fixed or freestanding, such as Liko FreeSpan and Liko FreeStand. The system must be installed by authorized personnel and in accordance with Liko™ installation instructions.

Likorall overhead lift is intended for use in lifting and transferring patients, for example, from bed to a wheelchair, to or from the floor, for visits to the toilet, for gait, standing and balance training, when weighing the patient and when lifting the patient with a stretcher.

Likorall 200 overhead lift is adapted to the Liko™ Quick-release Hook System for safe and easy changing of lifting accessories.

The Liko™ Room-to-Room system (R2R), enables the patient to be moved between two rail systems in separate rooms, without connecting rails and without making holes over doors.

A large range of accessories are available for Likorall overhead lift, including different sling models in a range of types and sizes.

In this document, the person being lifted is referred to as the patient, and the person helping them is referred to as the caregiver.



IMPORTANT!

























Lifting and transferring a patient always involves a certain level of risk. Read the instructions for use for both the patient lift and lifting accessories before use. It is important to completely understand the contents of the instructions for use. The equipment should only be used by trained personnel. Ensure that the lifting accessories are suitable for the lift used. Exercise care and caution during use. As a caregiver, you are always responsible for the patient's safety. You must be aware of the patient's ability to make it through the lifting situation. If something is unclear, contact the manufacturer or supplier.

Table of Contents

Symbol Description	3
Safety Instructions	4
Definitions	5
Technical Data	5
Measurements	6
EMC Table.....	6
Assembly	9
Operation	9
Charging the Batteries	12
Transferring from Room to Room.....	13
Maximum Load.....	14
Recommended Lifting Accessories	14
Simple Troubleshooting.....	16
Recycling Instructions.....	17
Cleaning and Disinfection	18
Inspection and Maintenance	22

Symbol Description

These symbols can be found in this document and/or on the product.

Symbol	Description
	For indoor use only.
	The product has extra protection against electric shock (Insulation Class II).
	Protection level against electric shock Type B.
	Warning. Used where extra care and attention is needed.
	Read instruction for use before use.
	This product complies with EC directives.
IP N ₁ N ₂	Protection level against: ingress of solid objects (N1) and ingress of water (N2).
	Manufacturer.
	Date of manufacture.
	Caution! consult instructions for use.
	Battery.
	All batteries in this product must be recycled separately. - Pb underneath the symbol indicate batteries containing lead - Single Black line underneath the symbol indicate this product have been placed on the market after 2005.
	UL Recognized Component Mark for Canada and the United States.
	EFUP, Environmental Friendly Usage Period (years).
	Environmentally-friendly product which can be recycled and reused.
	The Australian Safety/EMC.
	PSE Mark (Japan).
	Product Identifier.
	Serial Number.
	Medical Device.
	Recyclable.
	The safety and essential performance of medical electrical equipment.
	Proof of Product compliance to North American safety standards.
	Non-ionizing electromagnetic radiation.
	Duty cycle for non-continuous operation. The maximum active operation time X% of any given time unit, followed by a deactivation time, Y%. The active operation time shall not exceed the specified time in minutes, T.
	GS1 Data Matrix Barcode that may contain following information (01) Global Trade Item Number (11) Production Date (21) Serial Number

Safety Instructions

⚠️ Installation of Likorall overhead lift to carriages shall be made by personnel authorized by Liko™ in accordance with the installation instructions and recommendations for the current lift system.

Intended use: The product is intended for use in following environments: Health care, Intensive care, Emergency ward, Rehabilitation, Habilitation environment. This product is not intended to be used by the patient alone. Lifting and transferring a patient shall always be performed with the assistance of at least one caregiver. This product is used as a means to perform the lift but is not in contact with the patient; therefore we do not go into the various patient conditions in this instruction for use. Contact your Hill-Rom representative for support and advice.

Before using the lift the first time make sure that:

- the lift is assembled in accordance with the assembly instruction
- the lifting accessories are properly attached to the lift
- the batteries are charged for at least 8 hours
- you have read the instructions for use for the lift and lifting accessories
- personnel using the lift are informed of the correct use of the lift and lifting accessories
- the lifting accessory is selected appropriately, in terms of type, size, material and design with regard to the patient's needs.

Before lifting always ensure that:

- the lift strap is not twisted or worn and can move in and out of the lift unit freely
- the lifting accessories are not damaged
- the sling is correctly and securely applied to the patient in order to prevent injuries from occurring
- the lifting accessory is correctly applied to the lift
- the lifting accessories hang vertically and can move freely
- the sling bar latches are intact; missing or damaged latches must always be replaced
- the sling strap loops are correctly connected to the sling bar hooks when the sling's strap is extended upward, but before the patient is lifted from the underlying surface.

⚠️ Incorrect attachment of sling to slingbar may cause severe injury to the patient.

⚠️ If the Likorall is installed in the S65 carriage with single hook, make sure it is resting securely at the bottom of the hook and is not tilted.

⚠️ Never leave a patient unattended during a lifting situation!

⚠️ Only use the Likorall™ overhead lift with a carriage, adapter, sling bar and other accessories approved by Hill-Rom.



Likorall 200 is tested by an accredited testing institute.

⚠️ No modification of this product is allowed.

⚠️ Portable RF communications equipment (including peripherals such as antenna cables and external antennas) should be used no closer than 30 cm (12 inches) to any part of the lift, including cables specified by the manufacturer. Otherwise, degradation of the performance of this equipment could result.

⚠️ Use of the product adjacent to other equipment should be avoided because it could result in improper operation, if such use is necessary, observe and verify that the other equipment is operating normally.

Electromagnetic disturbance, may affect the lifting performance of the product. Modification using other parts than original spare parts (cables etc.) may affect the electromagnetic compatibility of the product.

Particular care must be observed when using strong sources of electromagnetic disturbance, such as diathermy, etc, so that diathermy cables are not positioned on or near the lift. If you have questions, please consult the responsible assistive-device technician or the supplier.

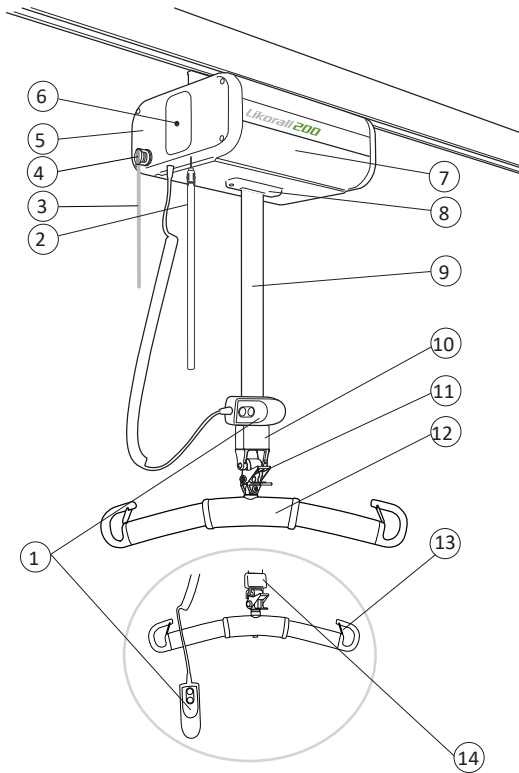

The lift may not be used in areas where flammable mixtures may occur, for example in areas where flammable goods are stored.

Definitions



1. Hand control with spring clamp
2. Emergency lowering device (electric)
3. Emergency stop string
4. Emergency stop
5. End cover
6. Charge indicator
7. Lift unit
8. SSP Limit Switch
9. Lift strap
10. Q-Link II (quick fastener)
11. Quick-release hook
12. Sling bar
13. Latches
14. Q-Link (quick fastener)

Technical Data

Maximum load:	200 kg (440 lbs.)	Intermittent power:	Int. Op 10/90, active operation max 30 sec.
Batteries:	2 x 12V 2,4-2,6 Ah. Valve-regulated lead-acid gel-type batteries. New batteries are provided by the supplier.	Protection class lift motor:	IP 33
Battery charger:	CH01 FW7218M/24; 100-240 V AC, 50-60 Hz, max 500 mA	Sound level:	51 dB
Lifting speed:	50 mm/s (2 inch./s)	Protection class hand control:	IP 54
Lifting interval:	2050 mm (80.7 inch.)	Operating forces hand control:	3 N
Electrical data:	24 V, 12 A	Cable length hand control:	870 mm (34 inch.)
Lift unit dimensions:	340x250x165 mm (LxWxH) (13.4x9.8x6.5 inch. ,LxWxH)	 Intended for indoor use.	
Lift unit weight:	12.5 kg (27.5 lbs.)	 Type B, in accordance with the electrical shock protection class.	
Emergency lowering device:	Electrical		

Likorall overhead lift is equipped with a SFS (Single Fault Safety) safety drum. This patented safety design provides protection against uncontrolled lowering.

Measurements

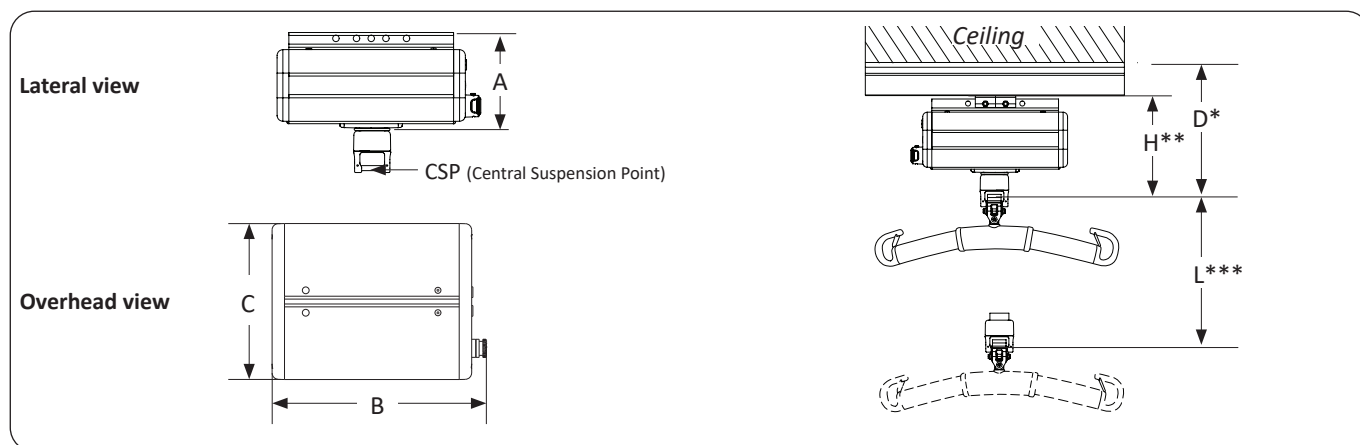

Measurements in mm.

A	B	C	D*	H**	L***
165	340	250	304	221	2050

Measurements in inch.

A	B	C	D*	H**	L***
6.5	13.4	9.8	12.0	8.7	80.7

* Minimum distance from ceiling to CSP at maximum lifting height with the standard carriage.

** Built-in dimension: the distance between the attachment point for the lift unit on the carriage and the CSP at maximum lifting height.

*** Lifting interval: the distance between maximum lifting height and minimum lifting height measured in CSP.

EMC Table

Guidance and manufacturer's declaration – electromagnetic emissions		
The product is intended for use in the electromagnetic environment specified below. The customer or the user of this product should assure that it is used in such an environment.		
Emissions test	Compliance	Electromagnetic environment - guidance
RF emissions CISPR 11	Group 1	The product uses RF energy only for its internal function. Therefore, its RF emissions are very low and are not likely to cause any interference in nearby electronic equipment.
RF emissions CISPR 11	Class B	The product is suitable for use in all establishments other than domestic and those directly connected to the public low-voltage power supply network that supplies buildings used for domestic purposes.
Harmonic emissions IEC 61000-3-2	Class A	
Voltage fluctuations/ flicker emissions IEC 61000-3-3	Complies	

Guidance and manufacturer's declaration – electromagnetic immunity

The product is intended for use in the electromagnetic environment specified below. The customer or the user of this product should assure that it is used in such an environment.

Immunity test	IEC 60601 test level	Compliance level	Electromagnetic environment - guidance
Electrostatic discharge (ESD) IEC 61000-4-2	+/- 6 kV contact +/- 8 kV air	+/- 6 kV contact +/- 8 kV air	
Electrical fast transient / Burst IEC 61000-4-4	+/- 2 kV for power supply lines +/- 1 kV for input/output lines	+/- 2 kV for power supply lines n/a. for input/output lines	Mains power quality should be that of a typical commercial or hospital environment.
Surge IEC 61000-4-5	+/- 1 kV differential mode +/- 2 kV common mode	+/- 1 kV differential mode n/a. for common mode	Mains power quality should be that of a typical commercial or hospital environment.
Voltage dips, short interruptions and voltage variations on power supply input lines IEC 61000-4-11	<5 % U_T (>95 % dip in U_T) for 0,5 cycle 40 % U_T (60 % dip in U_T) for 5 cycles 70 % U_T (30 % dip in U_T) for 25 cycles <5 % U_T (>95 % dip in U_T) for 5 sec		
Power frequency (50/60 Hz) magnetic field IEC 61000-4-8	3 A/m	3 A/m	Power frequency magnetic fields should be at levels characteristic of a typical location in a typical commercial or hospital environment
Conducted RF IEC 61000-4-6	3 Vrms 150 kHz to 80 MHz	3 Vrms 150 kHz to 80 MHz	
Radiated RF IEC 61000-4-3	10 V/m 80MHz to 2,5GHz	10 V/m 80MHz to 2,5GHz	

NOTE U_T is the a.c. mains voltage prior to application of the test level.

Guidance and manufacturer's declaration – electromagnetic immunity

The product is intended for use in the electromagnetic environment specified below. The customer or the user of this product should assure that it is used in such an environment.

Immunity test	IEC 60601 test level	Compliance level	Electromagnetic environment - guidance
<p>Conducted RF IEC 61000-4-6</p> <p>Radiated RF IEC 61000-4-3</p>	<p>3 Vrms 150 kHz to 80 MHz</p> <p>10 V/m 80MHz to 2,5GHz</p>		<p>Portable and mobile RF communications equipment should be used no closer to any part of the product, including cables, than the recommended separation distance calculated from the equation applicable to the frequency of the transmitter.</p> <p>Recommended separation distance</p> $d = 0,35\sqrt{P}$ $d = 0,29\sqrt{P} \quad 80\text{MHz to }800\text{MHz}$ $d = 0,58\sqrt{P} \quad 800\text{MHz to }2,5\text{GHz}$ <p>where P is the maximum output power rating of the transmitter in watts (W) according to the transmitter manufacturer and d is the recommended separation distance in meters (m).</p> <p>Field strengths from fixed RF transmitters, as determined by an electromagnetic site survey, ^a should be less than the compliance level in each frequency range. ^b</p> <p>Interference may occur in the vicinity of equipment marked with the following symbol.</p> 

NOTE 1 At 80MHz and 800MHz, the higher frequency range applies.

NOTE 2 These guidelines may not apply in all situations. Electromagnetic propagation is affected by absorption and reflected from structures, objects and people.

^a Field strengths from fixed transmitters, such as base stations for radio (cellular/cordless) telephones and land mobile radios, amateur radio, AM and FM radio broadcast and TV broadcast cannot be predicted theoretically with accuracy. To assess the electromagnetic environment due to fixed RF transmitters, an electromagnetic site survey should be considered. If the measured field strength in the location in which the product is used exceeds the applicable RF compliance level above, the product should be observed to verify normal operation. If abnormal performance is observed, additional measures may be necessary, such as reorienting or relocating the product.

^b Over the frequency range 150 kHz to 80 MHz, field strengths should be less than 10 V/m.

Assembly

After assembly, ensure that:

- the lift's functions correspond to the markings of the hand control
- the electrical emergency lowering device functions properly
- the SSP Limit Switch functions properly
- the battery charger functions properly and the indicator lamps are illuminated during charging
- the batteries are charged for at least 8 hours before the lift is used for the first time.

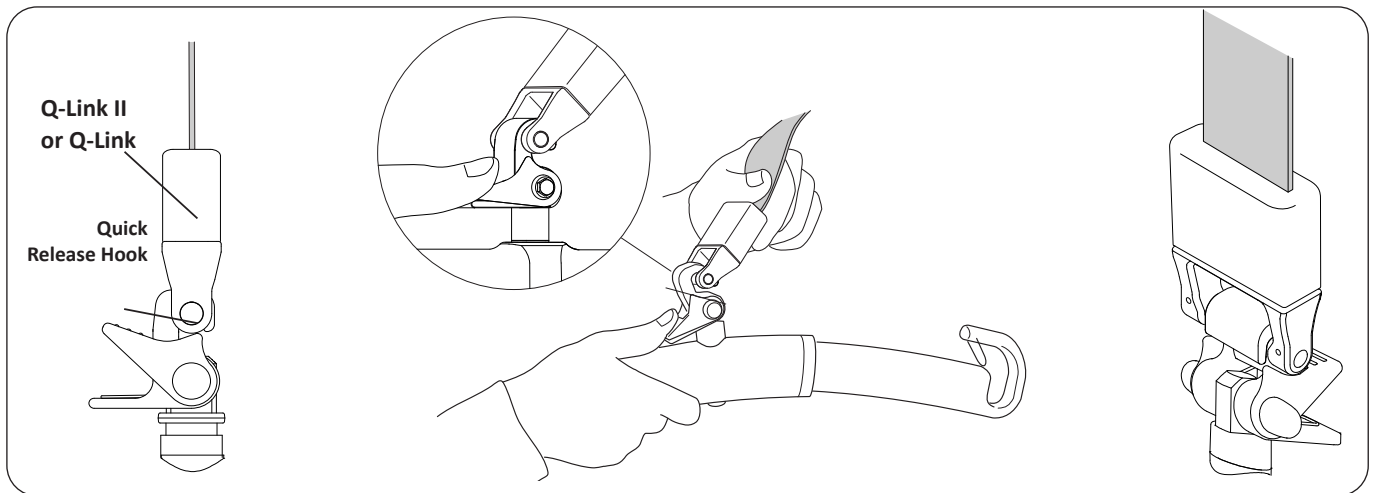

Lifting accessory with quick-release hook,

Push down the red catch and connect the quick-release hook to the Q-Link II or Q-Link. Release and check that the catch locks in order to prevent involuntary unhooking from the Q-Link II or Q-Link. Read more about the Liko™ Quick-release Hook system on page 15.

⚠ Before lifting check that the Quick-release Hook is correctly attached to the Q-Link II or Q-Link, see illustration above.

Operation

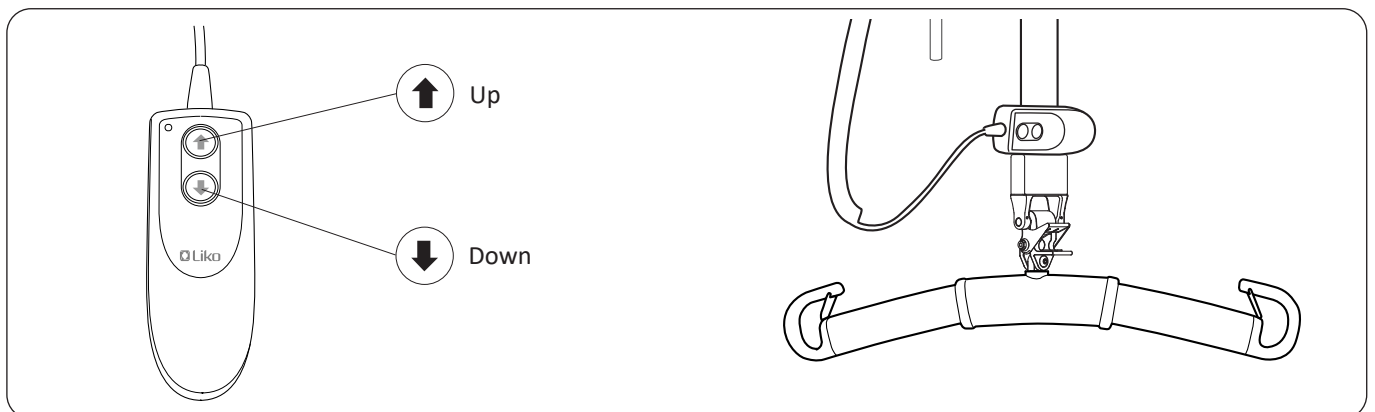

Manoeuvring

The lifting motion in Likorall™ 200 overhead lift is controlled using an attached hand control. Likorall™ 200 overhead lift is manoeuvred by pressing lightly on the hand control buttons. The arrows indicate direction. Motion ceases when the button is released.

Hand control with spring clamp

When the lift is not in use, the hand control can be attached to the lift strap using the spring clamp on the back side of the hand control.

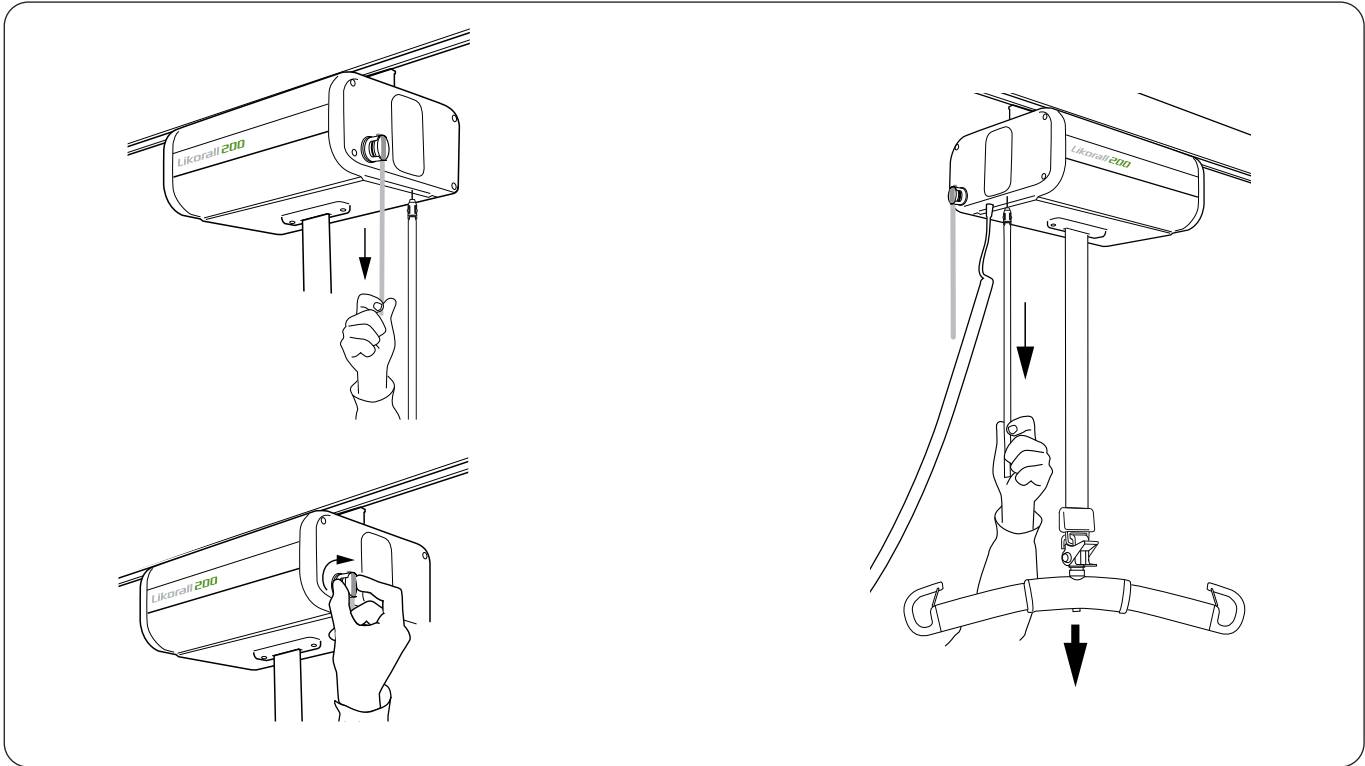

Emergency stop

To activate the emergency stop: pull the red emergency stop string.

To reset the emergency stop: turn the red emergency stop button in the direction shown by the arrows.

The red button on the lift unit end cover is intended for use if an emergency situation occurs. When the button is pressed, contact between the motor and power source is broken, which stops the lifting motion.

Electrical Emergency lowering

In the event that the hand control or electronics malfunction, the lift can be lowered by pulling on the emergency lowering device.

In the event of emergency lowering, always ensure the patient is lowered into a bed, wheelchair or other suitable place.

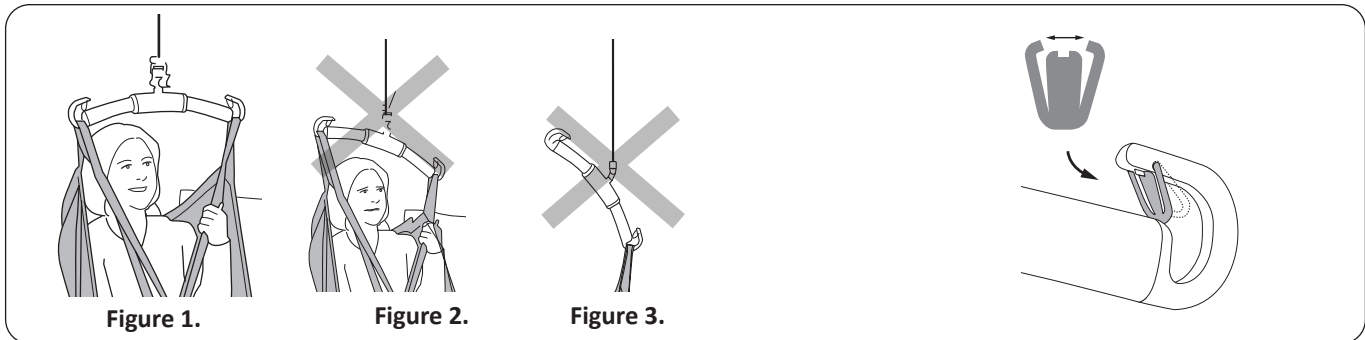

Figure 1.

Figure 2.

Figure 3.

Lift correctly!

Before each lift, make sure that:

- the Sling loops at opposite sides of the Sling are at the same height
- all the Sling loops are fastened securely in to the Slingbar hooks
- the Slingbar is level during the lift, see Figure 1.

⚠ If Slingbar is not level (see Figure 2) or if the sling loops are incorrectly attached to the slingbar (see Figure 3) lower the user to a firm surface and adjust according to the Instructions for use of Sling in use.

⚠ An improper lift can be uncomfortable for the user and cause damage to the lift equipment! (see Figure 2 and figure 3).

Installation of Latches

After installation, check that the latch locks and runs freely in the sling bar hook.

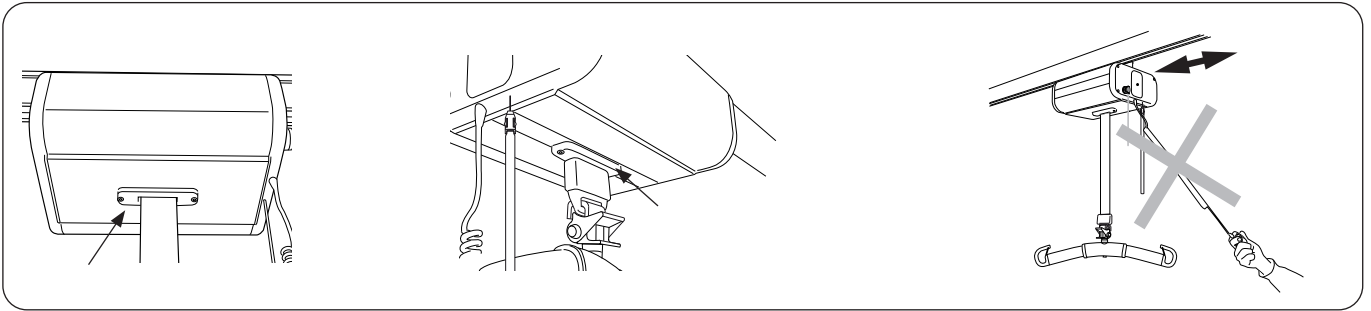

SSP Limit Switch

The lifting motion is stopped by lightly pressing on the SSP Limit Switch on the underside of the lift unit (see the illustration).

SSP Limit Switch activated by the Q-Link or Q-Link II

When Likorall overhead lift strap reaches its highest position and physical contact occurs between the SSP Limit Switch and Q-Link or Q-Link II, the SSP Limit Switch is activated. Its function stops the lifting motion electrically and protects the lift unit against mechanical load. The SSP Limit Switch also provides squeeze protection.

⚠ Never move the lift by pulling the hand control!

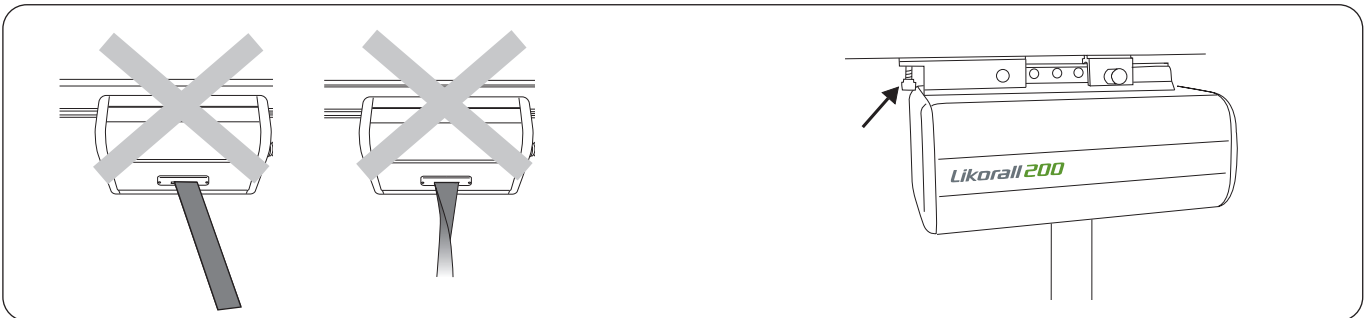

SSP Limit Switch activated by the Lift strap

It is important that the lift strap's lifting motion is performed as vertically as possible to ensure safe operation. The SSP Limit Switch is intended to stop the lifting motion if the lift strap is subjected to harmful strain, for example if it is pulled sideways or folded over during the lifting motion. If the SSP Limit Switch is activated so that the lifting motion stops, the lift can once again be operated after the lift strap is straight again (a short delay may occur when re-starting the lifting motion is normal in these cases).

Adjustable friction brake

The amount of drag on the lift unit is adjusted with the friction brake on the carriage. Turn the brake clockwise for increased resistance and counter clockwise to reduce resistance.

The following carriages have a friction brake:
prod. no. 3126011 and 3126015.

⚠ Be aware that the lift strap is kept straight and stretched when it runs in and out of the lift unit.

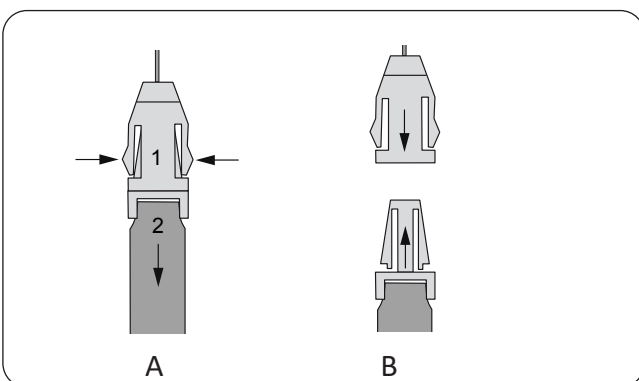

A: Loosen the emergency lowering device strap.

B: Fasten the emergency lowering device strap.

Charging the Batteries

In order to ensure maximum battery life, it is important to charge the batteries regularly. We recommend that you charge the batteries after use or every night.

A full charge is achieved after max. 8 hours. Fully charged batteries will last for approx. 60 lift cycles.

1. Check to ensure that the emergency stop button is not pressed in during charging.
2. Place the hand control in the charging station and connect the charger.
3. Connect the charger to a 100-240 V AC electric socket.
4. A LED on the hand control will illuminate and indicates that the charger is connected to a power source.
5. Charging starts automatically and a yellow LED on the lift unit indicates that the batteries are charging.
6. When the battery is fully charged, the charger will shut off automatically and the yellow LED turns off.

NOTE! When the lift will not be in use for a long period of time, place the hand control in the charger unit in order to charge the battery.

Charge indicator

Likorall overhead lift has two indicators warning when the battery has a low charge:

- Buzzer that sounds when lifting
- LED that illuminates during lifting

When either of these warning signals sound or illuminate, the unit should be charged as soon as possible.

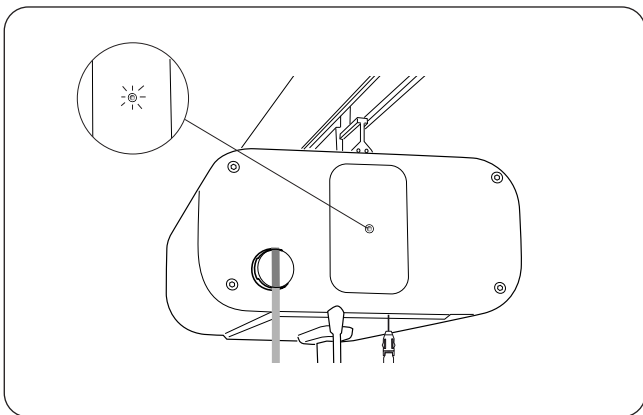
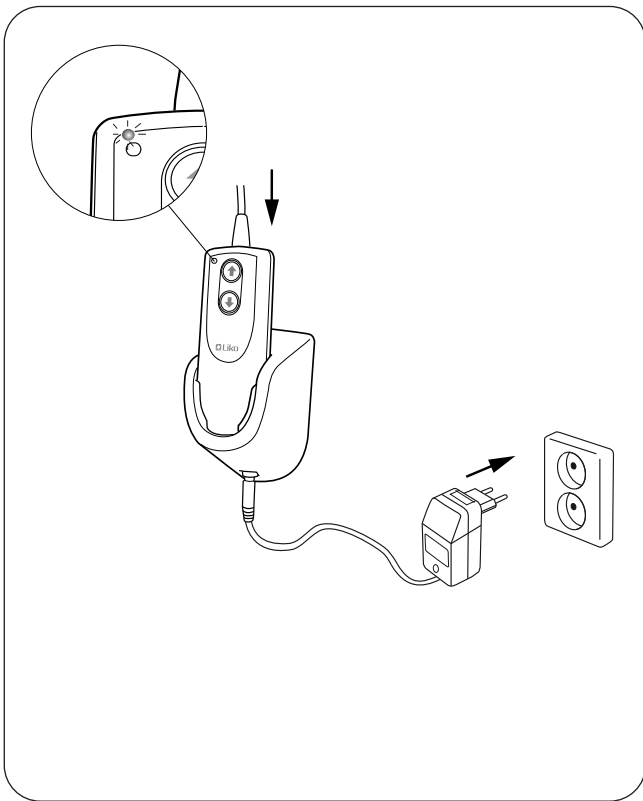

Transferring from room to room

The Liko™ Room-to-Room (R2R) system is an effective solution for safe transfer of patients between two or more rooms. The R2R system is mounted without making openings in walls over doors and full isolation is therefore retained between the rooms supported by the system.

The transfer is performed in a safe manner, with the aid of separate rail systems for each room. The Liko™ R2R system enables linking together two Likorall overhead lifts when transferring from room to room. The actual transfer operation between two rooms is performed with a comfortable transition for the patient from one Likorall overhead lift to another.

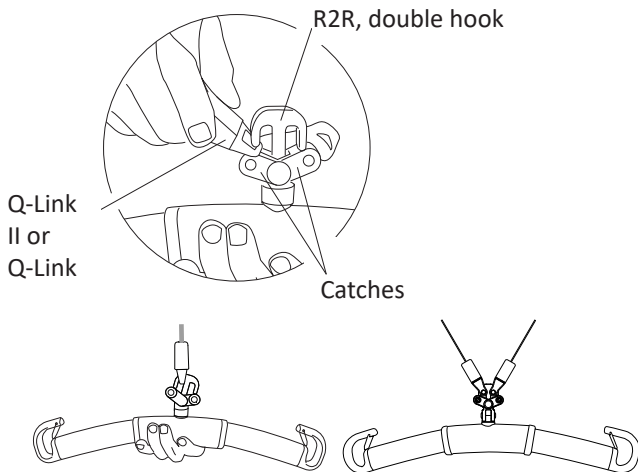

Mounting a Q-Link II or Q-Link to an R2R Sling Bar

The R2R sling bars with double hooks each fit two Q-Links. The two red catches keep the Q-Link II or Q-Link in place in the R2R double hook before any load is applied to the lift strap. Open the red catch gently when placing a Q-Link II or Q-Link in the R2R double hook.

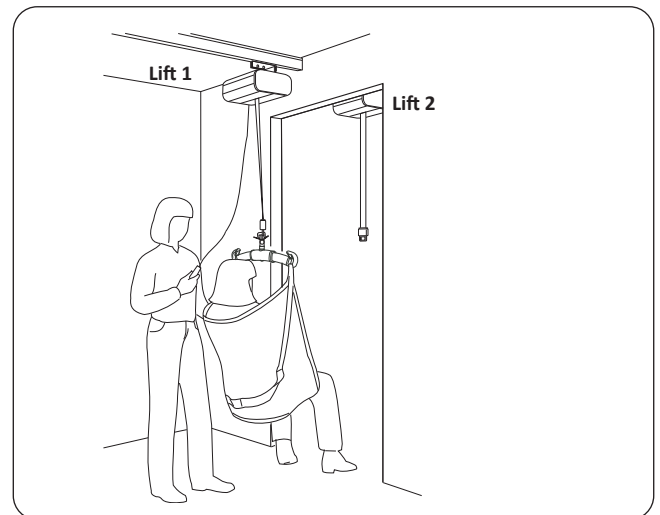

1. Move Lift 1 with the patient as close to the door way as possible. Lower the lift as far as possible, bearing in mind the patient's comfort.

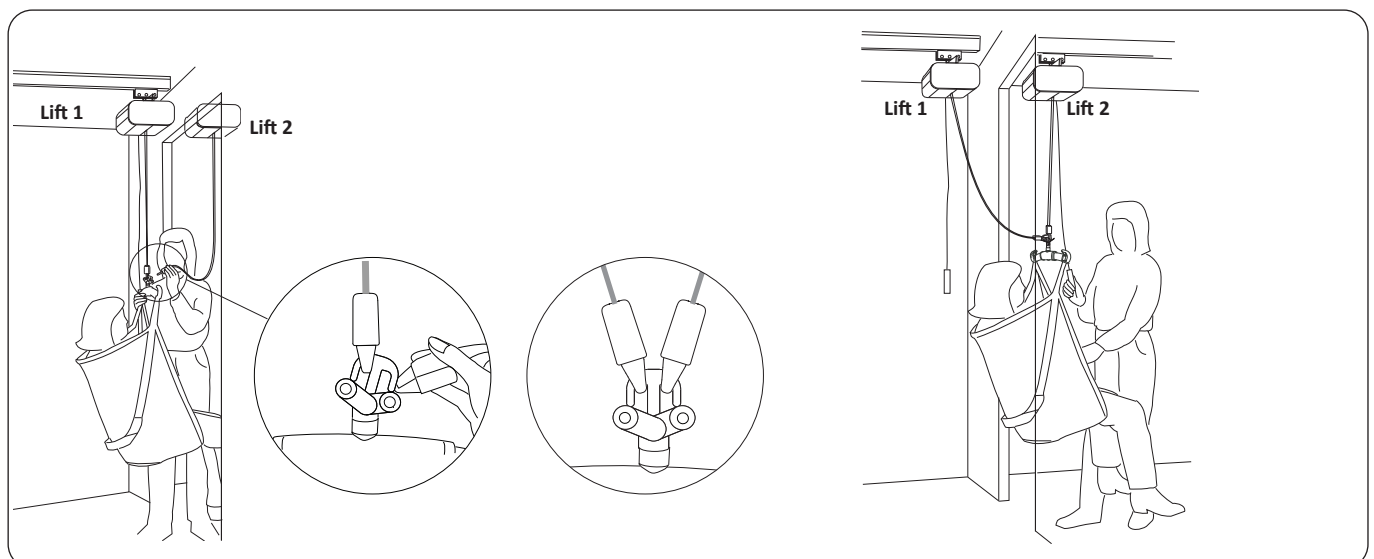

2. Move Lift 2 as close to the door opening as possible. Lower the lift strap from Lift 2 a sufficient length and connect the Q-Link II or Q-Link to the R2R sling bar. Check that the catches on the R2R double hook function properly.
NOTE! For transfer between multiple rooms a Carriage adjustable could be used instead of a lift motor.

3. Raise Lift 2. The patient is successively moved to the next room and finally suspended in Lift 2 only. When the pressure is relieved from the lift strap for Lift 1, disconnect the lift strap from the R2R sling bar and the transfer can be carried out in the next room.
NOTE! To free the Q-Link II or Q-Link from the R2R sling bar, it may be necessary to let out additional strap from Lift 1.

Maximum Load

Different maximum loads may apply to different products on the assembled lift system: rail system, lift, sling bar, sling and any other accessories used. For the assembled lift system, including accessories, the maximum load is always the lowest maximum load rating for any of the components. For example: a LikoTM overhead lift that is approved for 200 kg (440 lbs) can be equipped with a sling bar that is approved for 300 kg (660 lbs). In this case, the max load of 200 kg (440 lbs) applies to the assembled lift system. Study the markings on the lift and lifting accessories or contact your Hill-Rom representative if you have any questions.

Recommended Lifting Accessories

⚠ Using other lifting accessories than those recommended below may induce risk.

The LikoTM product range contains a wide assortment of sling bars, slings, stretchers, scales and other accessories to solve most lifting needs. Below is an overview of the lifting accessories available for LikoTM 200TM overhead lift. Some accessories may not be available for sale.

For additional guidance in selecting a sling, study the instructions for use for the respective sling models. There you will also find guidance for combining LikoTM sling bars with LikoTM slings.

Contact your Hill-Rom representative for advice and information on the LikoTM product range.

Universal SlingBar 350 R2R
Max. load 300 kg (660 lbs)

Prod. No. 3156094



Universal SlingBar 450 R2R
Max. load 300 kg (660 lbs)

Prod. No. 3156095



Universal SlingBar 350 with Quick-release Hook
Max. load 300 kg (660 lbs)

Prod. No. 3156084



Universal SlingBar 450 with Quick-release Hook
Max. load 300 kg (660 lbs)

Prod. No. 3156085



Universal SlingBar 600 with Quick-release Hook
Max. load 300 kg (660 lbs)

Prod. No. 3156086



Universal SlingBar 670 Twin with Quick-release Hook
Max. load 300 kg (660 lbs)

Prod. No. 3156087



Universal SideBars 450
including bag
Max. load 300 kg (660 lbs)

Prod. No. 3156079

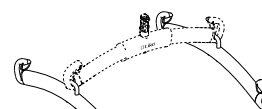

Sling Cross-bar 450 with Quick-release Hook
Max. load 300 kg (660 lbs)

Prod. No. 3156022

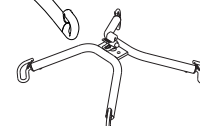

Sling Cross-bar 670 with Quick-release Hook
Max. load 300 kg (660 lbs)

Prod. No. 3156019

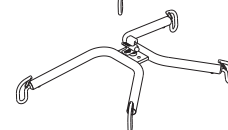

Carriage Adjustable
Carriage, adjustable 300-500 mm (12-20 in), R2R
Carriage, adjustable 500-900 mm (20-35 in), R2R
Carriage, adjustable 900-1300 mm (35-51 in), R2R

Prod. No. 3121660

Prod. No. 3121661

Prod. No. 3121662



Quick-release Hook

The Liko™ Quick-release Hooks form a system providing safe and easy changing of lifting accessories. The Liko™ Quick-release Hooks protect against unintentional detachment. Likorall 200 overhead lift is used solely with lifting accessories equipped with Quick-release Hooks.

Quick-release Hook Universal fits Universal SlingBar 350, 450 and 600 (Prod. No. 3156074-3156076).

Quick-release Hook TDM fits Sling Cross-bar 450 and 670 (Prod. No. 3156021 and 3156018) and Universal TwinBar 670 (Prod. No. 3156077). Contact your Hill-Rom representative for more information

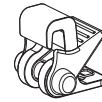

Quick-release Hook Universal
Prod. No. 3156508



Quick-release Hook TDM
Prod. No. 3156502

Battery Charger Likorall 200 overhead lift

- CH01 EU 24V/0.5A
- CH01 UK 24V/0.5A
- CH01 US/CA 24V/0.5A
- CH01 AU/NZ 24V/0.5A

- Prod. No. 3126131
- Prod. No. 3126132
- Prod. No. 3126133
- Prod. No. 3126134



Stretcher

Likorall can be used for horizontal lifting with:

- Liko™ FlexoStretch Prod. No. 3156057
 - Liko™ OctoStretch with Leveller Prod. No. 3156056
 - Liko™ Stretch Mod 600 IC, wide Prod. No. 3156065B
- Contact your Hill-Rom representative for more information

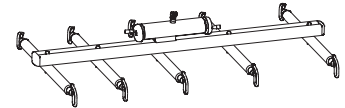

Scale

For weighing persons in combination with the use of Likorall overhead lift, we recommend LikoScale™ 350, Max 400 kg (880 lbs) Prod. No 3156228 This can easily be mounted with the LikoScale™ adapter kit. LikoScale™ 350 is certified according to the European Directive NAWI 2014/31/EU (Non Automatic Weighing Instruments)

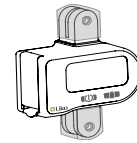

For United States and Canada only:
LikoScale™ 200, Max. 200 kg (440 lbs.) Prod. No. 3156225
LikoScale™ 400, Max. 400 kg (880 lbs.) Prod. No. 3156226
Contact your Hill-Rom representative for more information.



SlingBar Cover Paddy 30 Prod. No. 3607001
(fits Universal SlingBars 350, 450 and 600, as well as SlingBar Slim 350)



Parking Panel 600, LR/MR Prod. no. 3126075
Parking Panel 1500, LR/MR Prod. no. 3126080
Can be completed with the following accessories:

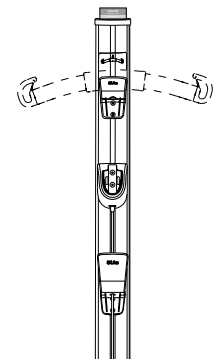

Hook for SlingBar Prod. no. 3126070
Hook for Accessories Prod. no. 3126071
Quick Reference Guide (see respective product)

Carriage Adapter Likorall for S65. Prod. no. 3126030



Simple Troubleshooting

The lift doesn't work.



1. Make sure that the emergency stop button has not been activated (shall not be pressed in).
2. Check that the handcontrol cable is connected correctly.
3. Charge the battery.
4. If the problem persists, please contact Hill-Rom.

A repeated signal can be heard from the lift.



1. Charge the battery immediately.
2. If the problem persists, please contact Hill-Rom.

The lift emits a repeated LED signal.



1. Charge the battery immediately.
2. If the problem persists, please contact Hill-Rom.

The lift is stuck in the high position.



1. Make sure that the emergency stop button has not been activated (shall not be pressed in).
2. Check that the handcontrol cable is connected correctly.
3. Use the selected electrical emergency lowering device to lower the patient onto a firm surface.
4. Charge the battery.
5. If the problem persists, please contact Hill-Rom.

The lift does not achieve maximum lifting capacity.



1. Charge the battery.
2. If the problem persists, please contact Hill-Rom.

In event of unusual sounds or any leakage from the lift



Please contact Hill-Rom.

Recycling Instructions

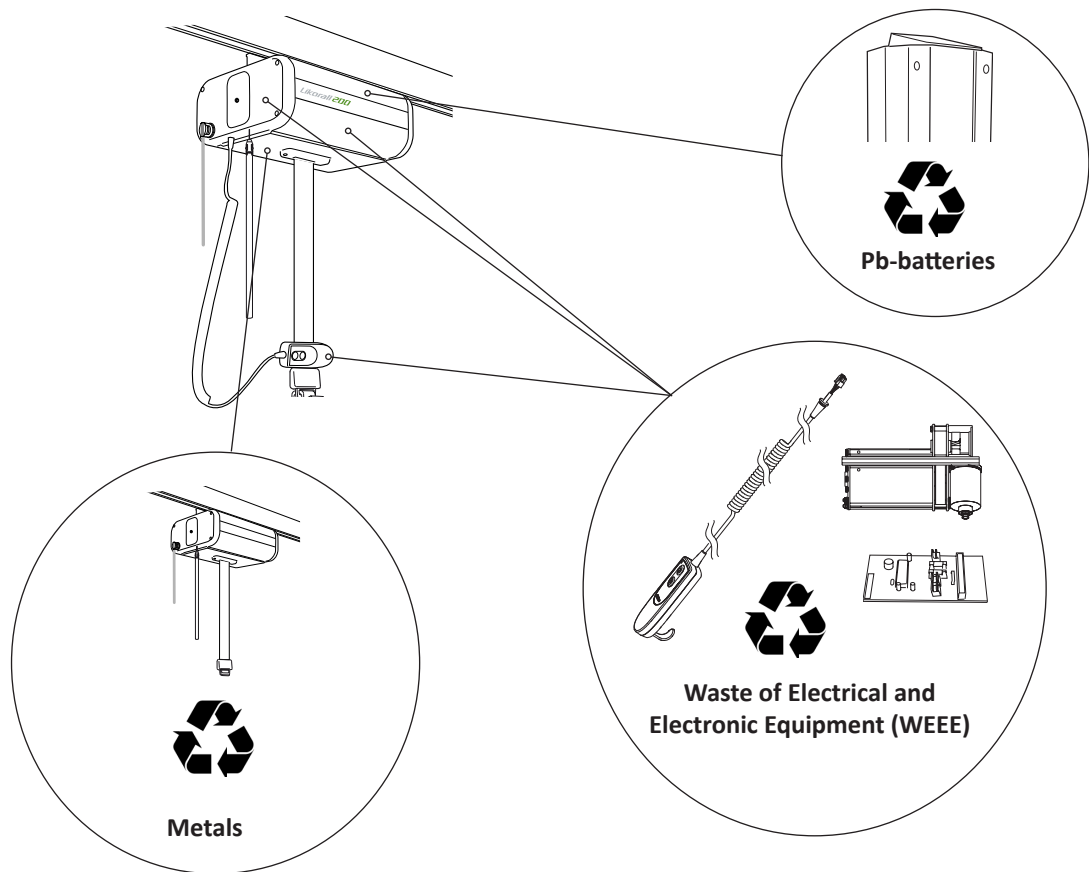

Old batteries are to be deposited at the nearest recycling station or given to personnel authorized by Hill-Rom. Likorall overhead lift comply with the Directive 2012/19/EEC on waste electrical and electronic equipment.

Hill-Rom evaluates and provides guidance to its users on the safe handling and disposal of its devices to aid in the prevention of injury, including, but not limited to: cuts, punctures of the skin, abrasions, and any required cleaning and disinfection of the medical device after use and prior to its disposal. Customers should adhere to all federal, state, regional, and/or local laws and regulations as it pertains to the safe disposal of medical devices and accessories.

If in doubt, the user of the device shall first contact Hill-Rom Technical Support for guidance on safe disposal protocols.

Cleaning and Disinfection

These instructions do not replace the facility's own cleaning and disinfection policies.

Warnings:

To help prevent injury and/or equipment damage, obey these warnings:

- Warning—The potential for electrical shock exists with electrical equipment. Failure to follow facility protocol could cause death or serious injury.
- Warning—Do not reuse wiping material for multiple steps or on multiple products.
- Warning—Harmful cleaning solutions may cause skin rash and/or irritation upon contact. Follow the manufacturer's instructions found on the product label and Safety Data Sheet (SDS).
- Warning—Lift and move items correctly. Do not twist, and seek assistance when necessary.
- Warning—Fluid spills on to the lift electronics could cause a hazard. If this happens do not put the lift back into service until it is completely dry, tested, and found to be safe to operate.

Cautions:

To help prevent equipment damage, obey these cautions:

- Caution—Do not steam clean or power wash the lift. Pressure and excessive moisture can damage the protective surfaces of the lift and its electrical components.
- Caution—Do not use harsh cleansers/detergents, heavy duty grease removers, solvents such as toluene, xylene, or acetone, and do not use scouring pads (you may use a soft bristle brush).
- Caution—Fully extend the lift strap prior to the cleaning and disinfection process.

Safety Recommendations

- Wear protective equipment according to manufacturer's instruction and per facility protocol throughout the cleaning operations, such as: gloves, eye protection, apron, face mask and shoe covers.
- Unplug mains (AC power source) before cleaning and disinfection.
- Never clean the lift by pouring water on it, steam cleaning it, or by using a high-pressure jet.
- Refer to the recommendations made by the cleaning and disinfecting product manufacturer.

Process Recommendations:

For proper cleaning and disinfection, staff members should be trained.

The trainer should carefully read the instructions and follow them when the trainee is being trained.

The trainee should:

- Be given time to read the instructions and to ask any questions.
- Clean and disinfect the product while the trainer supervises. During, and/or after this process, the trainer should correct the trainee about any differences from the instructions for use.

The trainer should supervise the trainee until the trainee can clean and disinfect the lift as instructed.

Hill-Rom recommends to clean and disinfect the lift between patient use and regularly during extended patient stays.

Some fluids used in the hospital environment, such as iodophor and zinc oxide creams, can cause permanent stains. Remove temporary stains by wiping vigorously with a lightly-dampened wiping cloth.

Cleaning and Disinfection Overview:

Cleaning and disinfection are distinctly different processes. **Cleaning** is the physical removal of visible and non-visible soil and contaminants. **Disinfection** is intended to kill microorganisms.

When you perform the detailed cleaning steps, please note the following:

-  Do not use harsh cleansers/detergents, heavy duty grease removers, solvents such as toluene, xylene, or acetone, and do not use scouring pads (you may use a soft bristle brush).
- A microfiber cloth is recommended as the wiping cloth.
- Always replace the wiping cloth when visibly soiled.
- Always replace the wiping cloth between steps (spot clean, clean, and disinfect)
- Always use Personal Protective Equipment (PPE) such as gloves, eye protection, apron, face mask, and shoe covers, as recommended by the facility protocol and manufacturers instructions

Cleaning and Disinfection Equipment:

- Protective equipment (such as: gloves, eye protection, apron, face mask and shoe covers) as recommended by the facility protocol and manufacturers instructions
- Disposable microfiber cloths recommended
- Soft bristle brush (Hill-Rom recommends a soft bristle brush for cleaning.)
- Warm water
- To find Cleaning / Disinfectants compatible or not compatible for use on Liko™ products, follow the "Application of commonly used Cleaning / Disinfectants on Liko products" in this document.

Prepare the Unit for Cleaning and Disinfecting:

1. ⚠️ **Unplug mains (AC power source) before cleaning and disinfection.**
2. Fully extend the lift strap by using the emergency lowering.

Step 1: Cleaning

1. Unplug the mains (AC power source) before cleaning and disinfection.
2. As necessary, first remove visible soil from the lift with a cloth moistened with warm water and a neutral, approved cleaner/disinfectant. See "Application of commonly used Cleaning / Disinfectants on Liko products." Do not use a cloth that is dripping wet.
 - A soft bristle brush may be used for hard-to-clean areas to remove stains and resistant dirt and to loosen hardened soil.
 - Use as many wiping cloths as needed to remove the soil. Replace cloth when soiled.
 - After cleaning the lift strap, make sure it is dry before you raise the sling bar.
3. Wipe down the entire lift starting from the top down. Give special attention to seams, cracks and other areas where soil may accumulate. In particular, pay special attention to the following areas:
 - Lift strap
 - Electrical emergency lowering/raising
 - Emergency stop
 - Emergency stop cord
 - Sling bar
 - Hand control

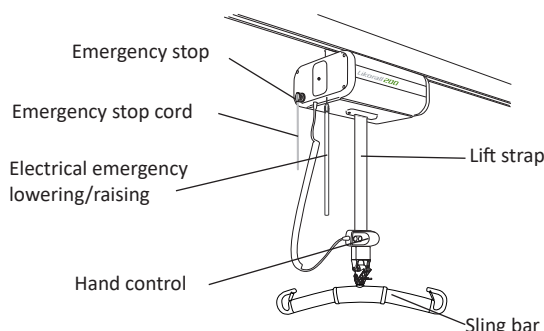

Cleaner/Disinfection:

NOTE:

It is important to remove all visible soil from all areas before continuing to remove non-visible soil.

With a new wiping cloth soaked in an approved cleaner/disinfectant, use firm pressure to wipe all surfaces of the lift. Use a new or clean wiping cloth as often as necessary. Make sure the following items are cleaned:

- Hand Control of
- Lift Motor
- Lift Strap
- Scale (if applicable)
- Connection points
- Any part of the rail that may be soiled
- Sling (refer to the specific sling Instructions for use and 7EN160884 Care and Maintenance Liko Slings)
- Power cord

Damaged items should be replaced!

Step 2: Disinfection:

1. For the use of suitable disinfectants see "Application of commonly used Cleaning / Disinfectants on Liko products" in this document.
2. Follow the manufacturer's instructions.
3. Make sure all surfaces **remain wet with the cleaner/disinfectant** for the **specified contact time**. Rewet surfaces with a new wiping cloth as necessary and per the manufacturer's instructions. Additional disinfection may need to be applied to maintain the required "wet" time.

NOTE:

If bleach is used with another cleaner/disinfectant, use a new or clean cloth/wipe soaked in tap water to remove any disinfectant residue prior to and after the bleach application.

 **The lift may not be cleaned with CSI or equivalent.**

 **The hand control may not be cleaned with Viraguard or equivalent.**

 **The lift strap may not be cleaned with Oxivir Tb, Dispatch, Chlor-Clean, Dismozon Pur or equivalent.**

Application of commonly used Cleaning / Disinfectants on Liko™ products

Chemical class	Active ingredient	pH	Cleaners / Disinfectant *)	Manufacturer *)	May not be used on the following items:
Quaternary ammonium chloride	Didecyl dimethyl ammonium chloride = 8.704% Alkyl dimethyl benzyl ammonium chloride = 8.19%	9.0 – 10.0 in use	Virex II (256)	Johnson/Diversey	Foot rest for Sabina™ and Roll-On™
Quaternary ammonium chloride	Alkyl dimethyl benzyl ammonium chloride = 13.238% Alkyl dimethyl ethylbenzyl ammonium chloride = 13.238%	9.5 in use	HB Quat 25L	3M	
Accelerated Hydrogen Peroxide	Hydrogen Peroxide 0.1 -1.5% BenzylAlcohol: 1-5% Hydrogen Peroxide 0.1 -1.5% BenzylAlcohol: 1-5%	3	Oxivir Tb	Johnson/Diversey	The lift straps for Golvo™ and ceiling lifts
Phenolic	Ortho-Phenylphenol = 3.40% Ortho-Benzyl-para-Chlorophenol = 3.03	3.1 +/- 0.4 in use	Wexcide	Wexford Labs	
Bleach	Sodium hypochlorite	12.2	Dispatch	Caltech	The lift straps for Golvo™ and ceiling lifts
Alcohol	Isopropyl alcohol = 70%	5.0 – 7.0	Viraguard	Veridien	Hand controls for all lifts
Quaternary ammonium	n-Alkyl dimethyl benzyl ammonium chlorides = 0.105% n-Alkyl dimethyl ethylbenzyl ammonium chlorides = 0.105%	11.5 - 12.5	CSI	Central Solutions Inc.	Viking™, Liko M220™, Liko M230™, Uno™, Sabina™, Golvo™, LikoLight™, Roll-On™, LikoLight™, Multirall™
Benzyl-C12-18-alkyldimethylammonium, chlorides	Benzyl-C12-18-alkyldimethylammonium, chlorides (22 %) 2-Phenoxyethanol (20 %) Tridecylpolyethylenglycolether (15 %) Propan-2-ol (8 %)	approx 8.6 in use	Terralin Protect	Shülke	Foot rest for Sabina™ and Roll-On™
Organic peroxide (type E, solid)	Magnesium monoperoxyphthalate hexahydrate (50-100%) Anionic surfactant (5-10%) Nonionic surfactant (1-5%)	5.3 in use	Dismozon Pur	Bode	The lift straps for Golvo™ and ceiling lifts
Ethanol	Hydrogen peroxide (2.5-10 %) Lauryldimethylamine oxid (0-2.5 %) Ethanol (2.5-10 %)	7	Anioxy-Spray WS	Anios	Control box for all mobile lifts
Trociolene sodium	Adipic acid 10-30% Amorphous silica < 1% Sodium Toluene sulphionate 5-10 % Trociolene sodium 10-30 %	4-6 in use	Chlor-Clean	Guest Medical Ltd	The lift straps for Golvo™ and ceiling lifts

*) Or equivalent

Inspection and Maintenance

For trouble-free operation, certain details should be checked each day the lift is used:

- Inspect the lift and check to make sure that there is no external damage.
- Check the sling bar attachment.
- Check the lift strap for wear and to ensure the strap is not twisted.
- Check the functionality of the latches.
- Check the operation of the lift movement.
- Check to make sure that the electrical emergency lowering functions correctly.
- Charge the batteries each day the lift is used and check to ensure that the charger works.

Clean the lift with a moist cloth. Find more detailed information regarding cleaning and disinfection of your Liko™ product in the chapter “*Cleaning and Disinfection*”.

⚠ The lift should not be exposed to running water.

Service

A periodic inspection of the lift should be carried out at least once per year.

⚠ Periodic inspection, repair and maintenance should be performed only in accordance with the Liko™ Service Manual and by personnel authorized by Hill-Rom and using original Liko™ spare parts.

⚠ Service activities are not allowed with the patient in the lift.

Service Agreement

Hill-Rom offers the opportunity to enter into service contracts for the maintenance and periodic inspection of your Liko™ products.

Expected Life Time

The product has an expected life time of 10 years when correctly handled, serviced and periodically inspected in accordance with Liko™ instructions.

Parts listed below are subject to wear and tear and have specific expected life time:

- Handcontrol, expected life time 2 years,
- Battery, expected life time 3 years.
- Liftstrap, expected life time 5 years.

Transport and Storage

During transportation, or when the lift is not to be used for a long time, the emergency stop should be engaged. The environment where the lift is transported and stored should have a temperature of -10°C to +50°C (14°F to 122°F) and a relative humidity of 20 to 90 %. The atmospheric pressure should be 700–1060 hPa.

Product Changes

Liko™ products undergo continuous development, which is why we reserve the right to make product changes without prior notice. Contact your Hill-Rom representative for advice and information about product upgrades.

Design and Quality by Liko™ in Sweden

Liko is quality certified according to ISO 9001 and its equivalence for the medical device industry, ISO 13485. Liko is also certified according to environmental standard ISO 14001.

Notice to Users and/or Patients in EU

Any serious incident that has occurred in relation to the device, should be reported to the manufacturer and the competent authority of the Member State in which the user and/or patient is established.



www.hillrom.com

Liko AB,
Nedre vägen 100
975 92 Luleå, Sweden
+46 (0)920 474700

Liko AB is a subsidiary of Hill-Rom Holdings inc.

Enhancing outcomes for
patients and their caregivers:

Hill-Rom